

PRODUCT FEATURES

- High short circuit capability, self limiting short circuit current
- IGBT CHIP(Highly rugged SPT+ design)
- $V_{CE(sat)}$ with positive temperature coefficient
- Ultra Low Loss, High Ruggedness
- Free wheeling diodes with fast and soft reverse recovery
- Temperature sense included

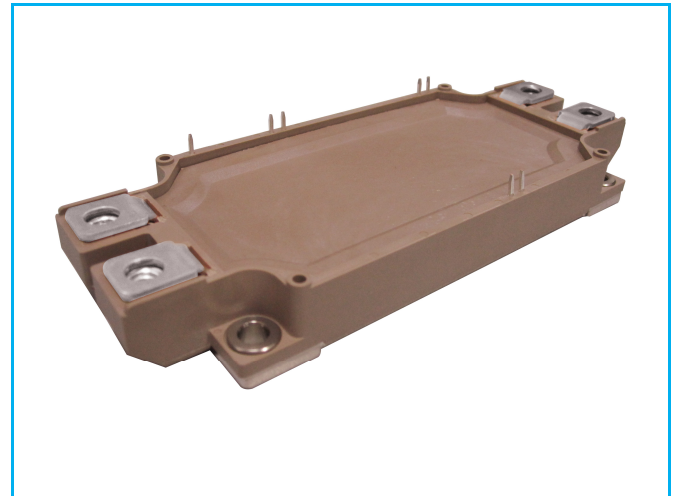

APPLICATIONS

- AC motor control
- Motion/servo control
- Inverter and power supplies
- Photovoltaic/Fuel cell

IGBT-inverter

ABSOLUTE MAXIMUM RATINGS ($T_C = 25^\circ\text{C}$ unless otherwise specified)

Symbol	Parameter/Test Conditions	Values	Unit
V_{CES}	Collector Emitter Voltage	$T_J = 25^\circ\text{C}$	V
V_{GES}	Gate Emitter Voltage		
I_C	DC Collector Current	$T_C = 25^\circ\text{C}, T_{Jmax} = 175^\circ\text{C}$	A
		$T_C = 100^\circ\text{C}, T_{Jmax} = 175^\circ\text{C}$	
I_{CM}	Repetitive Peak Collector Current	$t_p = 1\text{ms}$	
P_{tot}	Power Dissipation Per IGBT	$T_C = 25^\circ\text{C}, T_{Jmax} = 175^\circ\text{C}$	W

Diode-inverter

ABSOLUTE MAXIMUM RATINGS ($T_C = 25^\circ\text{C}$ unless otherwise specified)

Symbol	Parameter/Test Conditions	Values	Unit
V_{RRM}	Repetitive Reverse Voltage	$T_J = 25^\circ\text{C}$	V
$I_{F(AV)}$	Average Forward Current		A
I_{FRM}	Repetitive Peak Forward Current	$t_p = 1\text{ms}$	
I^2t		$T_J = 150^\circ\text{C}, t = 10\text{ms}, V_R = 0\text{V}$	A^2S

MacMic Science & Technology Co., Ltd.

Add: #18, Hua Shan Zhong Lu, New District, Changzhou City, Jiangsu Province, P. R. of China

MMG450WB170B

IGBT-inverter

ELECTRICAL CHARACTERISTICS ($T_C=25^\circ\text{C}$ unless otherwise specified)

Symbol	Parameter/Test Conditions		Min.	Typ.	Max.	Unit	
$V_{GE(th)}$	Gate Emitter Threshold Voltage	$V_{CE}=V_{GE}, I_C=18\text{mA}$	5.4	6.2	7.4	V	
$V_{CE(sat)}$	Collector Emitter Saturation Voltage	$I_C=450\text{A}, V_{GE}=15\text{V}, T_J=25^\circ\text{C}$		2.25	2.6		
		$I_C=450\text{A}, V_{GE}=15\text{V}, T_J=125^\circ\text{C}$		2.55			
		$I_C=450\text{A}, V_{GE}=15\text{V}, T_J=150^\circ\text{C}$		2.6			
I_{CES}	Collector Leakage Current	$V_{CE}=1700\text{V}, V_{GE}=0\text{V}, T_J=25^\circ\text{C}$			3	mA	
		$V_{CE}=1700\text{V}, V_{GE}=0\text{V}, T_J=150^\circ\text{C}$			20	mA	
I_{GES}	Gate Leakage Current	$V_{CE}=0\text{V}, V_{GE}=\pm 15\text{V}, T_J=25^\circ\text{C}$	-500		500	nA	
Q_g	Gate Charge	$V_{CE}=900\text{V}, I_C=450\text{A}, V_{GE}=\pm 15\text{V}$		3		μC	
C_{ies}	Input Capacitance	$V_{CE}=25\text{V}, V_{GE}=0\text{V}, f=1\text{MHz}$		27.5		nF	
C_{res}	Reverse Transfer Capacitance				1.6		nF
$t_{d(on)}$	Turn on Delay Time	$V_{CC}=900\text{V}, I_C=450\text{A}$ $R_G=3\Omega,$ $V_{GE}=\pm 15\text{V},$ Inductive Load	$T_J=25^\circ\text{C}$		210		ns
			$T_J=150^\circ\text{C}$		250		ns
t_r	Rise Time	Inductive Load	$T_J=25^\circ\text{C}$		170		ns
			$T_J=150^\circ\text{C}$		175		ns
$t_{d(off)}$	Turn off Delay Time	$V_{CC}=900\text{V}, I_C=450\text{A}$ $R_G=3\Omega,$ $V_{GE}=\pm 15\text{V},$ Inductive Load	$T_J=25^\circ\text{C}$		600		ns
			$T_J=150^\circ\text{C}$		700		ns
t_f	Fall Time	Inductive Load	$T_J=25^\circ\text{C}$		170		ns
			$T_J=150^\circ\text{C}$		310		ns
E_{on}	Turn on Energy	$V_{CC}=900\text{V}, I_C=450\text{A}$ $R_G=3\Omega,$ $V_{GE}=\pm 15\text{V},$ Inductive Load	$T_J=25^\circ\text{C}$		190		mJ
			$T_J=125^\circ\text{C}$		240		mJ
			$T_J=150^\circ\text{C}$		260		mJ
E_{off}	Turn off Energy	Inductive Load	$T_J=25^\circ\text{C}$		101		mJ
			$T_J=125^\circ\text{C}$		140		mJ
			$T_J=150^\circ\text{C}$		150		mJ
I_{SC}	Short Circuit Current	$tpsc \leq 10\mu\text{s}, V_{GE}=15\text{V}$ $T_J=150^\circ\text{C}, V_{CC}=1000\text{V}$		1440		A	
R_{thJC}	Junction to Case Thermal Resistance (Per IGBT)				0.055	K/W	

Diode-inverter

ELECTRICAL CHARACTERISTICS ($T_C=25^\circ\text{C}$ unless otherwise specified)

Symbol	Parameter/Test Conditions		Min.	Typ.	Max.	Unit
V_F	Forward Voltage	$I_F=450\text{A}, V_{GE}=0\text{V}, T_J=25^\circ\text{C}$		1.65	2.2	V
		$I_F=450\text{A}, V_{GE}=0\text{V}, T_J=125^\circ\text{C}$		1.75		
		$I_F=450\text{A}, V_{GE}=0\text{V}, T_J=150^\circ\text{C}$		1.8		
t_{rr}	Reverse Recovery Time	$I_F=450\text{A}, V_R=900\text{V}$		1000		ns
I_{RRM}	Max. Reverse Recovery Current	$dI_F/dt=-2500\text{A}/\mu\text{s}$		370		A
Q_{RR}	Reverse Recovery Charge	$T_J=150^\circ\text{C}$		175		μC
E_{rec}	Reverse Recovery Energy			130		mJ
R_{thJCD}	Junction to Case Thermal Resistance (Per Diode)				0.1	K/W

MMG450WB170B

NTC CHARACTERISTICS ($T_C=25^\circ\text{C}$ unless otherwise specified)

Symbol	Parameter/Test Conditions	Min.	Typ.	Max.	Unit
R_{25}	Resistance $T_C=25^\circ\text{C}$		5		K Ω
$B_{25/50}$	$R_2 = R_{25} \exp [B_{25/50}(1/T_2 - 1/(298.15 \text{ K}))]$		3375		K

MODULE CHARACTERISTICS ($T_C=25^\circ\text{C}$ unless otherwise specified)

Symbol	Parameter/Test Conditions	Values	Unit	
T_{Jmax}	Max. Junction Temperature	175	°C	
T_{Jop}	Operating Temperature	-40~150		
T_{stg}	Storage Temperature	-40~125		
V_{isol}	Isolation Breakdown Voltage	AC, 50Hz(R.M.S), t=1minute	4000	V
CTI	Comparative Tracking Index		> 225	
Torque	to heatsink	Recommended (M5)	2.5~5	Nm
	to terminal	Recommended (M6)	3~5	Nm
Weight			350	g

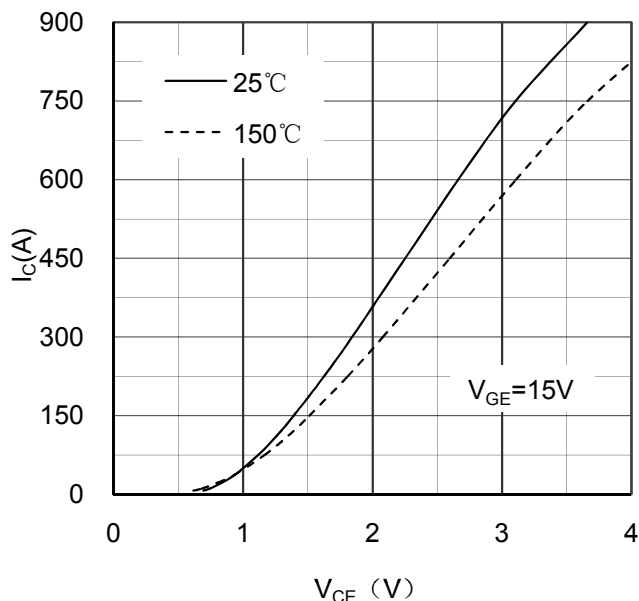

Figure 1. Typical Output Characteristics IGBT-inverter

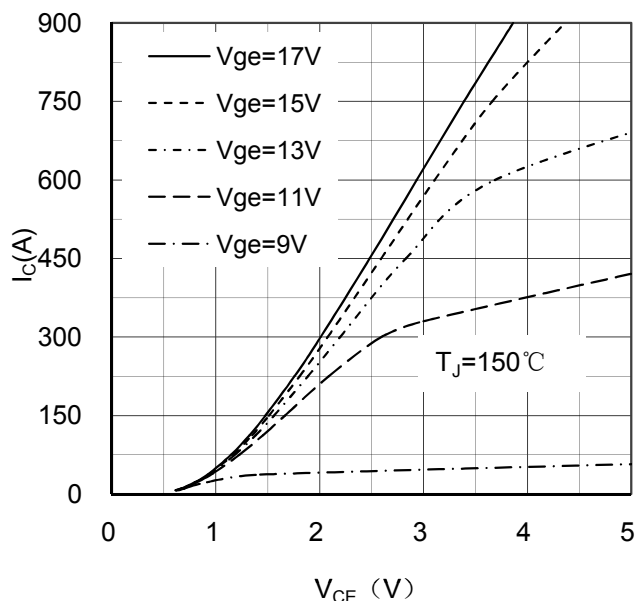

Figure 2. Typical Output Characteristics IGBT-inverter

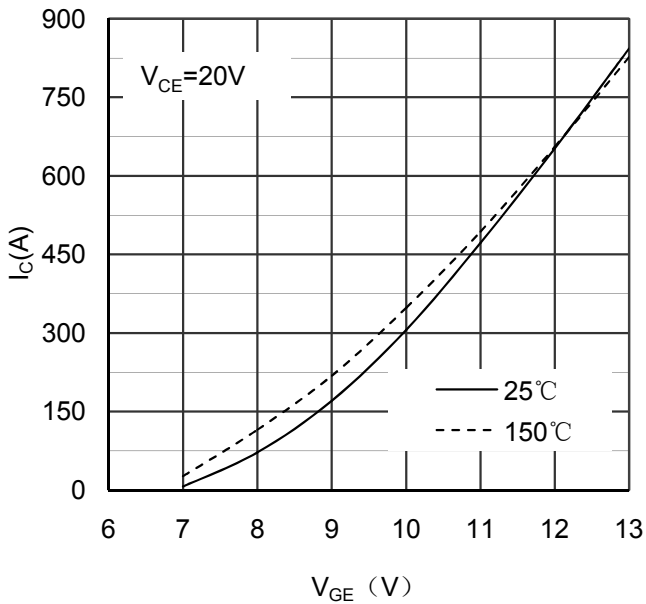

Figure 3. Typical Transfer characteristics IGBT-inverter

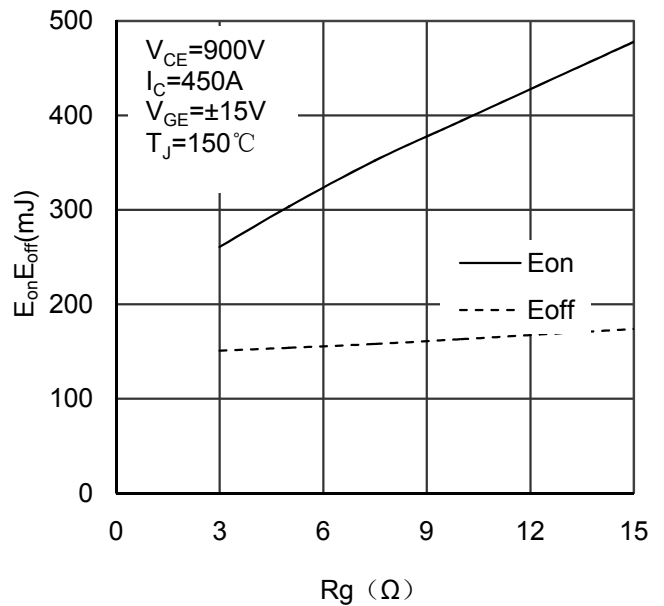

Figure 4. Switching Energy vs Gate Resistor IGBT-inverter

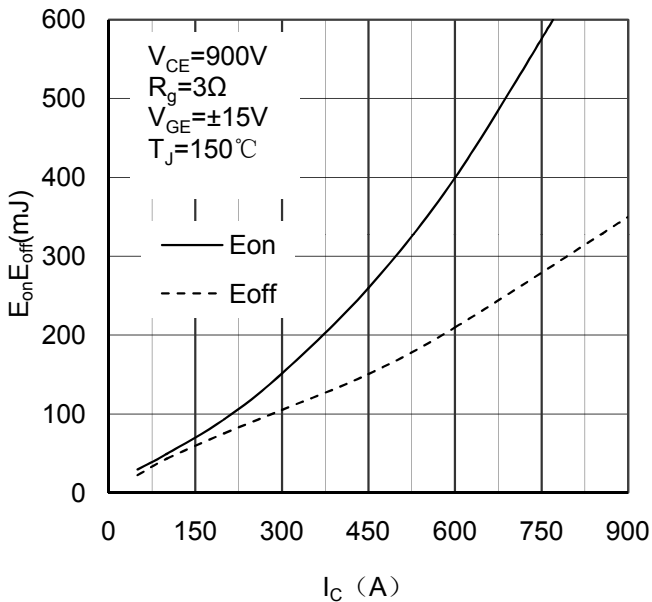

Figure 5. Switching Energy vs Collector Current IGBT-inverter

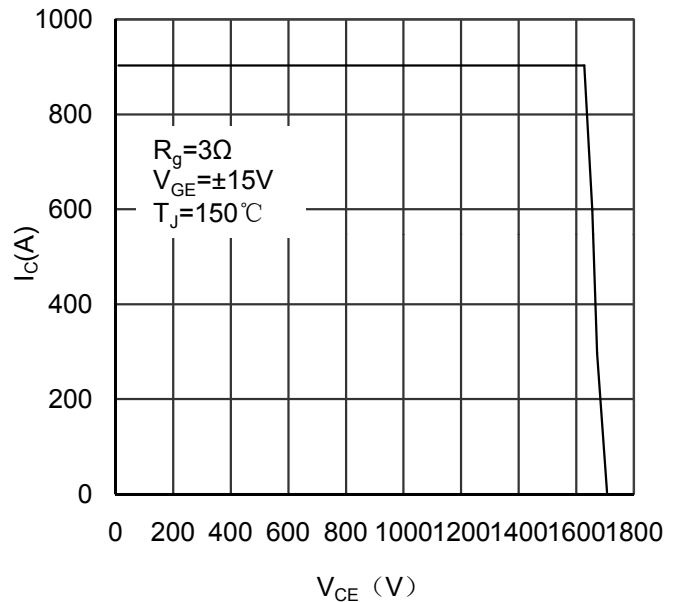

Figure 6. Reverse Biased Safe Operating Area IGBT-inverter

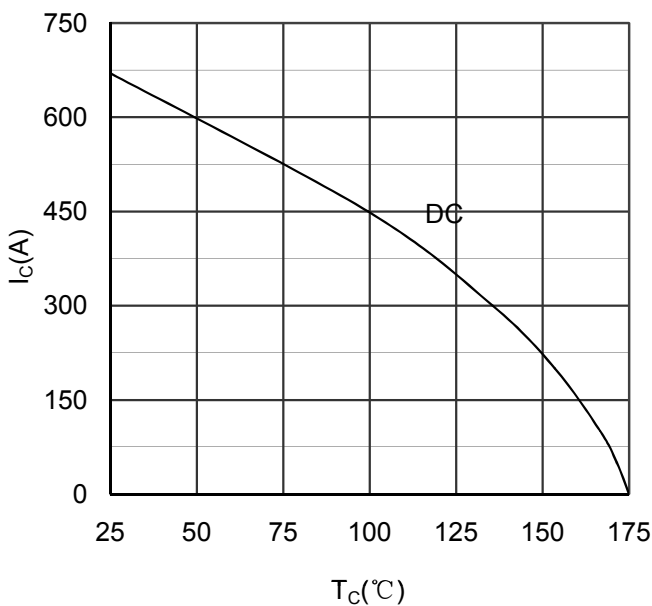

Figure 7. Collector Current vs Case temperature IGBT -inverter

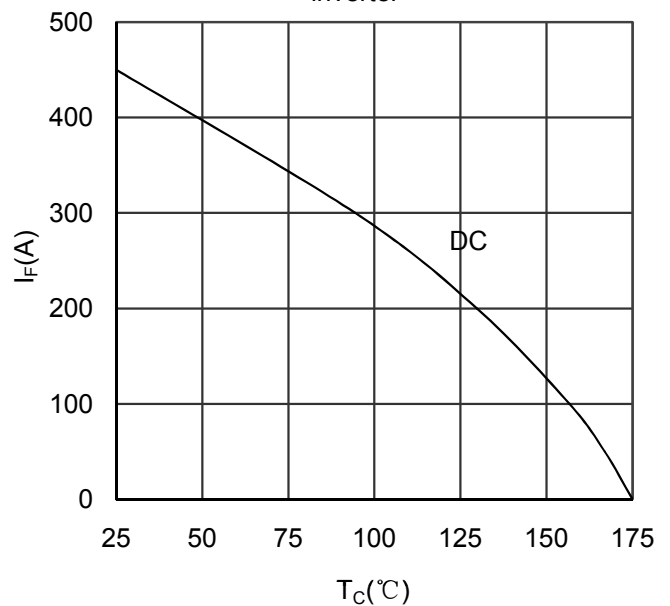

Figure 8. Forward current vs Case temperature Diode -inverter

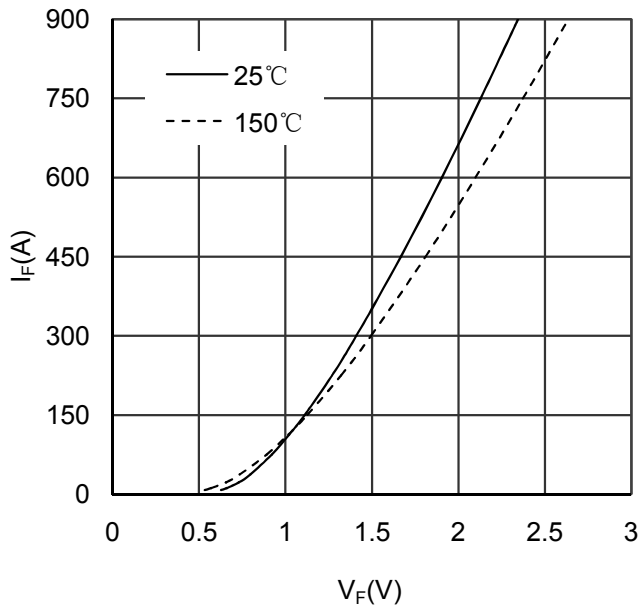

Figure 9. Diode Forward Characteristics Diode -inverter

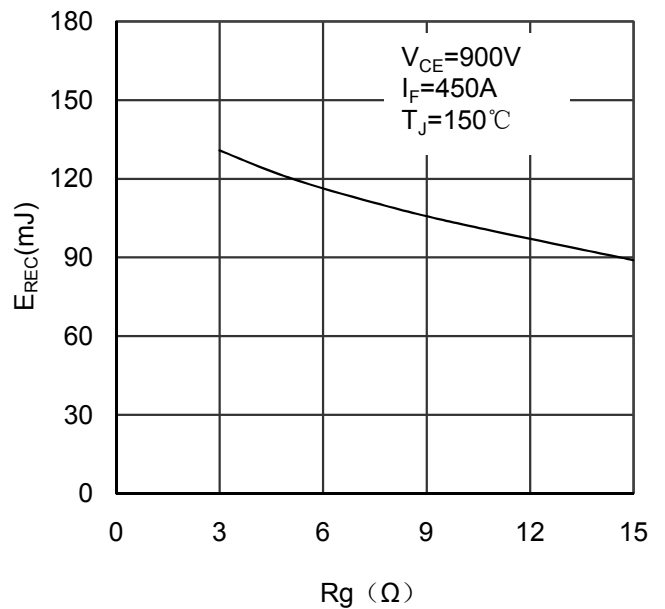

Figure 10. Switching Energy vs Gate Resistor Diode -inverter

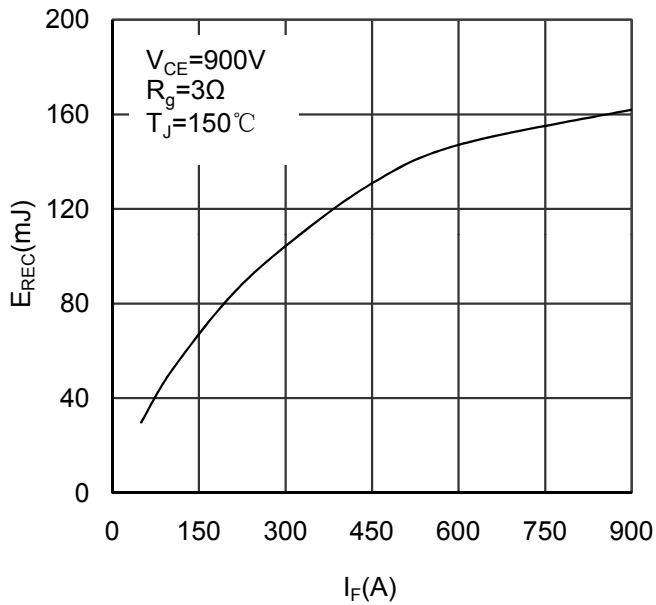

Figure 11. Switching Energy vs Forward Current Diode-inverter

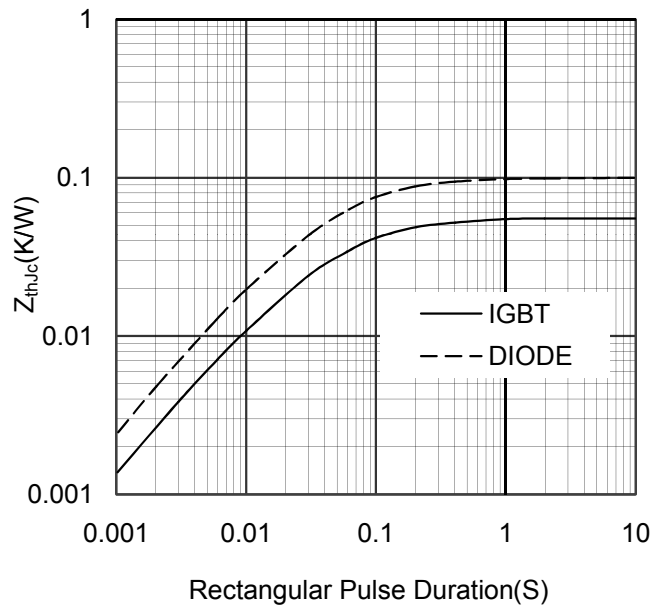

Figure 12. Transient Thermal Impedance of Diode and IGBT-inverter

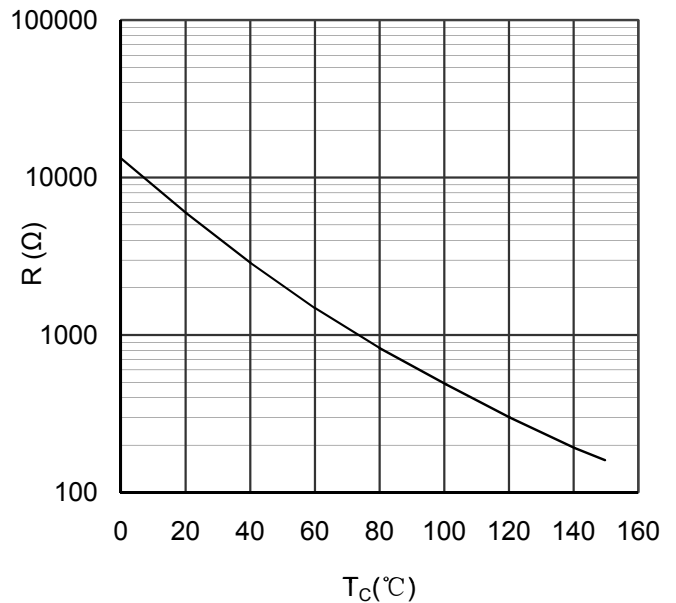

Figure 13. NTC Characteristics

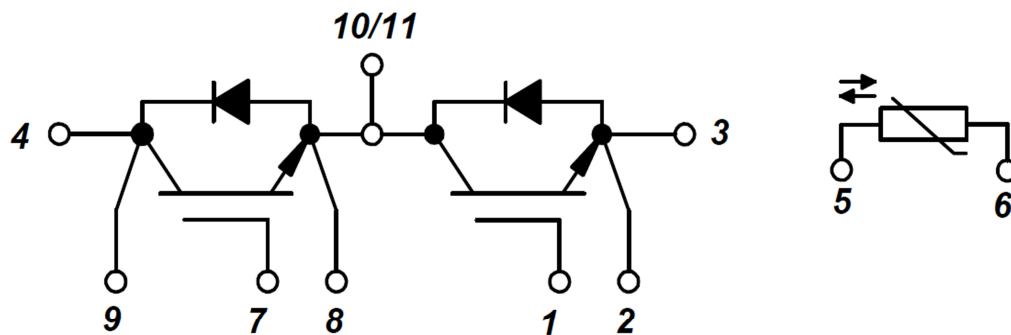
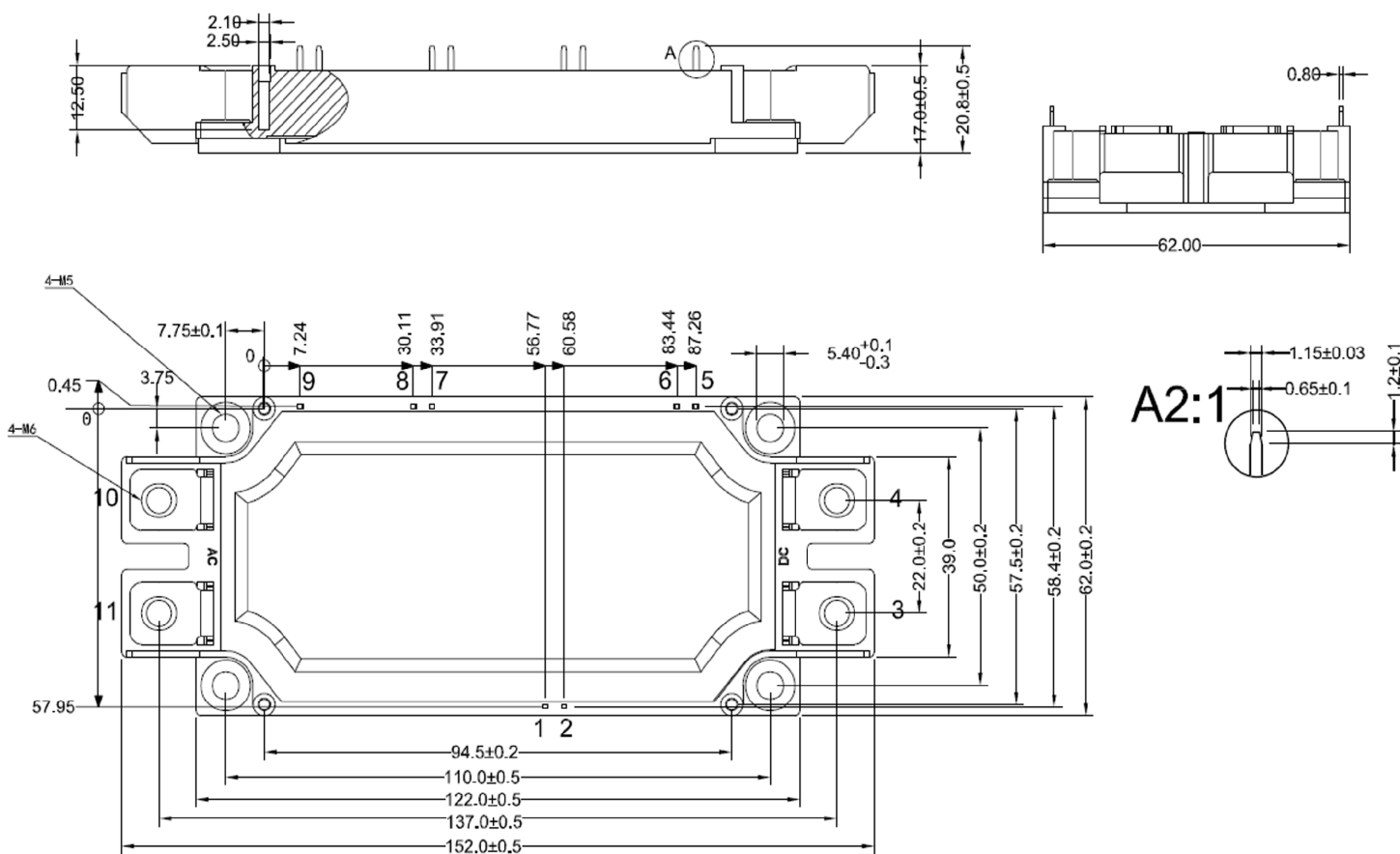

Figure 14. Circuit Diagram



Dimensions in (mm)

Figure 15. Package Outline